

**MAJLIS PERBANDARAN KANGAR, PERLIS**  
PROJEK BRIEF

**NO. SEBUTHARGA : MPK.Ps. SULIT 292**

**BERTARIKH : 09 OGOS 2022**

**BUTIRAN TAWARAN :**

Sebut harga kerja-kerja memasang *Digital Board* Perlis di Kuala Perlis, Perlis

**LOKASI :**

Kuala Perlis - Hadapan Konkos Jeti Kuala Perlis

**KOMPONEN / SKOP KERJA :**

**1. KERJA AWALAN**

- a) Kerja-kerja pembersihan tapak pembinaan.
- b) Kerja-kerja awalan yang terlibat adalah penyediaan insuran

**2. MEMBEKAL DAN MEMASANG PERALATAN LED DIGITAL BOARD**

- a) Membekal dan memasang LED Digital Billboard di lokasi :
  - i. Kuala Perlis

**3. KERJA-KERJA AWAM**

- a) Melantik Jurutera Bertauliah (PE) bagi kerja merekabentuk asas tapak konkrit serta kerja berkaitan. Jurutera bertauliah (PE) berkenaan perlu mengemukakan lukisan rekabentuk dan perkiraan rekabentuk yang disahkan sebanyak 2 salinan (asal).
- b) Kerja-kerja penyediaan tapak asas konkrit termasuk komponen berkaitan selaras dengan rekabentuk yang diperakukan oleh Jurutera Bertauliah (PE)
- c) Melantik Jurutera Bertauliah (PE) bagi kerja merekabentuk struktur keluli (bracket) untuk tujuan pemasangan LED digital board serta kerja berkaitan. Jutera bertauliah (PE) berkenaan perlu mengemukakan lukisan rekabentuk dan perkiraan rekabentuk yang disahkan sebanyak 2 salinan (asal).
- d) Kerja-kerja penyediaan struktur keluli (bracket) termasuk komponen berkaitan selaras dengan rekabentuk yang diperakukan oleh Jurutera Bertauliah (PE).
- e) Kerja-kerja kekemasan kawasan terlibat seperti keadaan asal

**4. KERJA-KERJA ELEKTRIKAL**

- a) Membekal dan memasang peti agihan "feeder pillar" 63Amp TPN (rujuk lampiran elektrik diagram)
- b) Kabel submin 4 x 16mm (Aluminium Armoured Cable) dari feeder pillar hingga ke panel kawalan LED screen.
- c) Menyediakan lukisan skematik dan elektrik diagram. (rujuk lampiran contoh elektrik diagram).
- d) Berurusan dengan pihak TNB bagi mendapatkan bekalan elektrik sehingga dapat digunakan.

MAJLIS PERBANDARAN KANGAR, PERLIS  
PROJEK BRIEF

NO. SEBUTHARGA : MPK.Ps. SULIT 292

BERTARIKH : 09 OGOS 2022

5. GAMBAR TAPAK



	CADANGAN MEMBEKAL DAN MEMASANG PAPAN IKLAN "BILLBOARD" DIGITAL DI KAWASAN KUALA PERLIS, ARAU DAN PADANG BESAR UNTUK MAJLIS PERBANDARAN KANGAR, PERLIS  - <i>Lokasi Kuala Perlis</i>	DI LUKIS OLEH	MNAR
		DI SEMAK OLEH	ZK
		TARIKH	JUN 2021

**MAJLIS PERBANDARAN KANGAR, PERLIS**  
**PROJEK BRIEF**

**NO. SEBUTHARGA : MPK.Ps. SULIT 292**

**BERTARIKH : 09 OGOS 2022**

**6. SPESIFIKASI TEKNIKAL**

**- Contoh LED Display Panel**

**LED DISPLAY PANEL PARAMETER | P8**

P8 Outdoor LED Display Parameter	
Brightness	5500-8000 cd/m2
Best Viewing Distance	≥ 8m
Working Voltage	AC 110V/220V ±10%
Average power consumption	400 W/ m2
Max power	800 W/m2
Life span	100,000 hours
IP grade	IP 65 / IP 67
Operating platform	Windows(WIN 2000/WIN 7/WIN 8/ WIN10/WIN XP..ETC.)

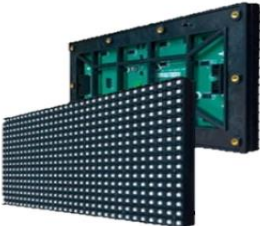

P8 Outdoor LED Module	
Pixel	8mm
LED	Nation Star/ Kinglight
IC	MBI 5124/ ICN 2038 S
Scan	1/4 s
Module Size	256*128 mm
Module Resoluti	32*16 dots
Pixel density	15,625 dots/ m2



P8 Outdoor LED Cabinet



P8 Outdoor LED Cabinet



Cabinet Assembly

\* For Submission Purposes Only

PROJ: PUSAT SAINS NEGARA, BUKIT KIARA	REV: 01	DATE: 15 JUN 21	DESCRIPTION:	BY: AR982	DESIGN BY: AR982	DATE: 15 JUN 21
TITLE:	REV:	DATE:	DESCRIPTION:	BY:	DESIGN BY:	DATE:

**- Contoh Panel Diagram**

**System Riser Diagram**

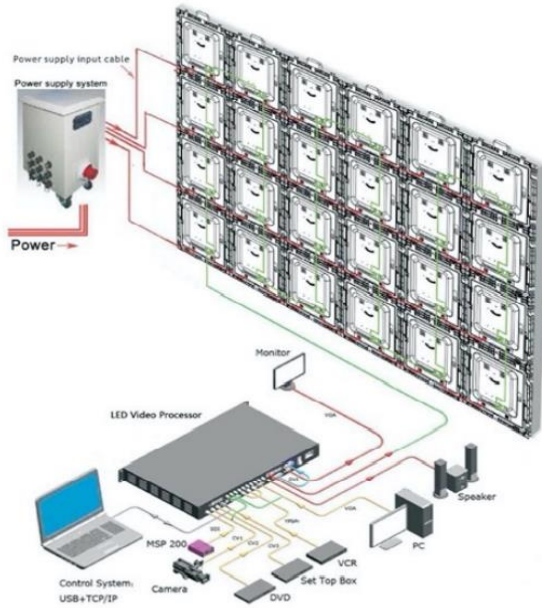

\* For Submission Purposes Only

PROJ: OUTDOOR LED DIGITAL BILLBOARD	REV: 01	DATE: 27 JULY 22	DESCRIPTION:	BY: AR982	DESIGN BY: AR982	DATE: 27 JULY 22
TITLE:	REV:	DATE:	DESCRIPTION:	BY:	DESIGN BY:	DATE:

**MAJLIS PERBANDARAN KANGAR, PERLIS**  
**PROJEK BRIEF**

**NO. SEBUTHARGA : MPK.Ps. SULIT 292**

**BERTARIKH : 09 OGOS 2022**

**- Contoh Lukisan Rekabentuk**

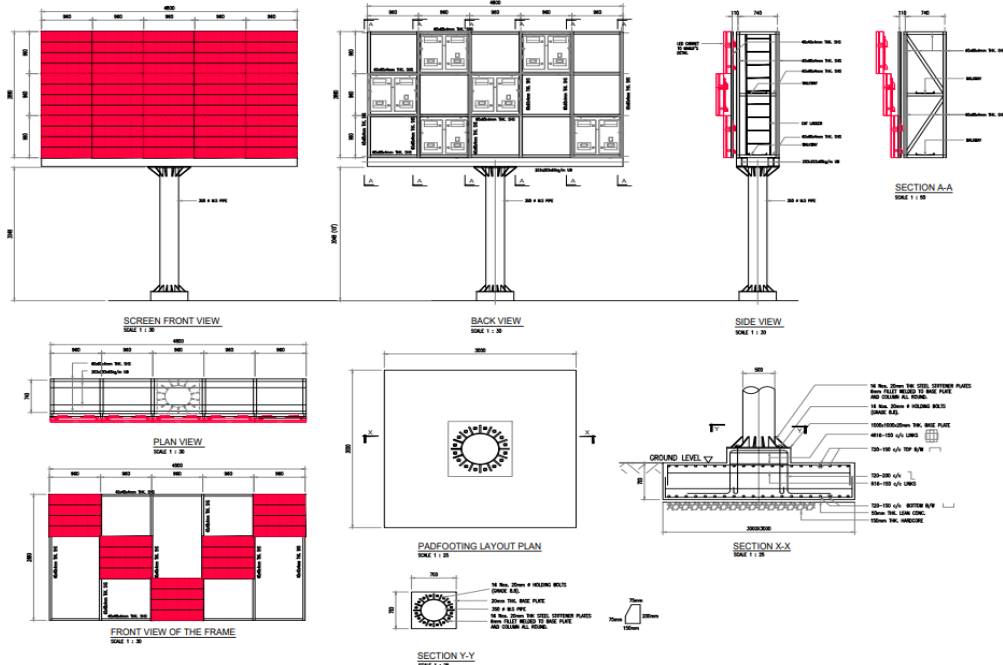

**- Contoh Elektrikal Diagram**

**OUTDOOR LED DISPLAY | ELECTRICAL DIAGRAM**

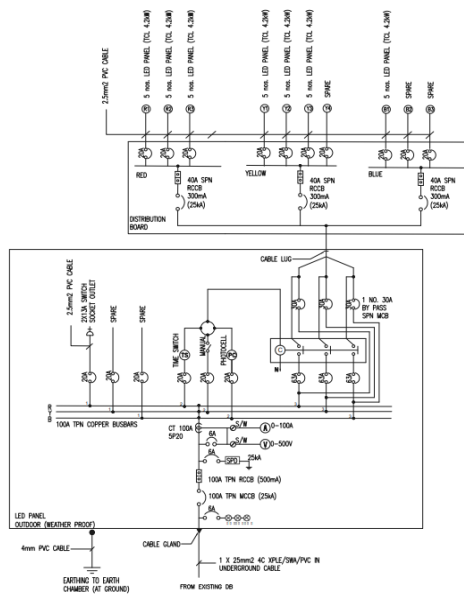

LEGEND	DESCRIPTION	BRAND
MCB	MINIATURE CIRCUIT BREAKER	EPS
C	CONTACTOR	LS
SS	SELECTOR SWITCH	SCHNEIDER
T	TIMER 24H	LEGRAND
MCCB	MOULDED CASE CIRCUIT BREAKER	LS
SPD	SURGE PROTECTOR DEVICE	MAXGUARD
⊕	INDICATION LIGHT	CS AUTO
⊕	EARTH LEAKAGE CIRCUIT BREAKER	LS
⊕	AMMETER	CS AUTO
⊕	VOLTAGE	CS AUTO

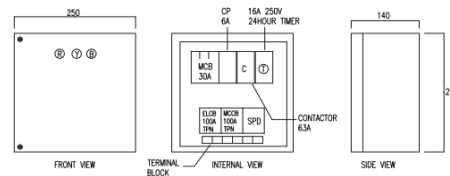

\* For Submission Purposes Only

NO.	REVISION	DATE	DESCRIPTION	BY	APPR.	DATE	REVISION	DATE	DESCRIPTION
01			OUTDOOR LED DIGITAL BILLBOARD						